

>>> TECHNICAL DATA

Main voltage: **230V/50Hz**

Nominal effect: **1x24, 1x36, 2x18, 2x24 or 2x36W**

Class: **I**

IP-Class: **IP20**

Equipped with: **230V HF-ballast or conventional ballast**

**Compact fluorescent tube; 1x24, 1x36, 2x18,
2x24 or 2x36W**

Tube model: L – 1xY = 2 G10, F – 2xY = 2 G11

>>> MOUNTING INSTRUCTIONS

Mount the lamp on a horizontal surface with the four attached M5-screws.

Hole pattern, see dimensional drawing on page 21.

Mounting accessory available for the Sunnex CLM-Series; C-clamp.

Plug in the cordset to 230V main socket. On/off function is handled with switch in lamphood.

>>> CHANGE THE FLUORESCENT TUBE

Disconnect cordset from main socket. Unscrew the gable part of lamphood, pull out the broken tube and replace with a new tube. Screw the gable part back in place.

Wattage - Comparison

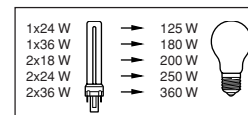

Fluorescent tube – Dulux L (left) and Dulux F (right)



>>> NOTE

Use only Sunnex original parts to secure the function and performance of Sunnex lighting-series.

If the screen is broken, it must be replaced by a new screen. If the cordset is damaged, it must be replaced with a new cordset and it should be done by the manufacturer or a person with sufficient electrical knowledge.

Contact your local dealer if you are unsure how to handle replacements on Sunnex CLM-series.

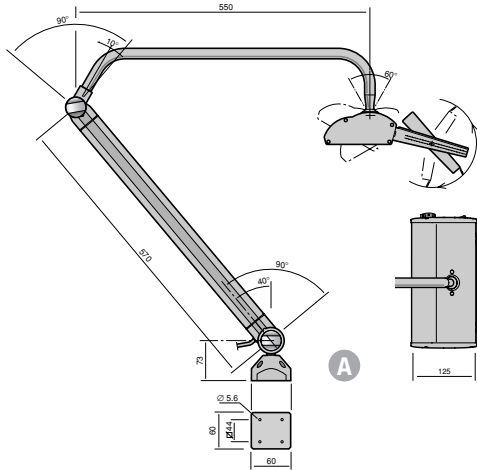

A

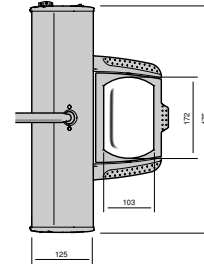
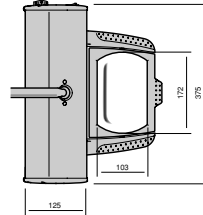
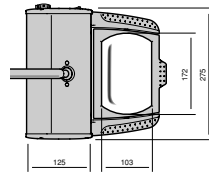

A Sunnex CLM – Articulated arm

- »» Arm length; 570 + 550 mm
- »» 230V – built-in ballast
- »» 3 diopter magnification = 1.75x
- »» With or without dimmer (only with HF-ballast)
- »» With or without flicker-free light
- »» With or without daylight fluorescent tube
- »» IP-Class; IP20
- »» Colour; Black and aluminum

Lux tables

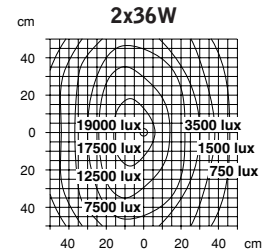
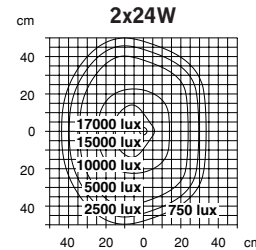
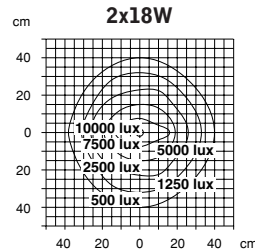
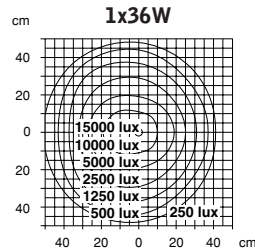
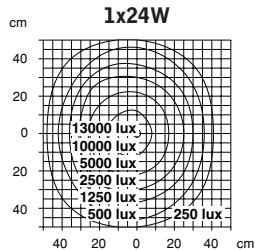

Measured 0,15 meters from the light source.